

# USER'S MANUAL

## AIR-CONDITIONER

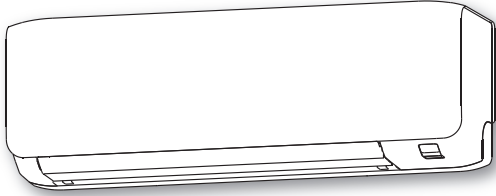

SRK20ZSA-W  
SRK25ZSA-W  
SRK35ZSA-W  
SRK50ZSA-W





Thank you for purchasing a MITSUBISHI HEAVY INDUSTRIES THERMAL SYSTEMS, LTD. Air-Conditioner. To get the best long-lasting performance, please read and follow this user's manual carefully before using your air-conditioner. After reading, please store the manual in a safe place and refer to it for operational questions or in the event of any irregularities.

This air-conditioner is intended for domestic and residential use.

This Product contains fluorinated greenhouse gases.  
Do not vent R32 into the atmosphere: R32 is a fluorinated greenhouse gas with a Global Warming Potential (GWP) = 675.  
Refer to a label on outdoor unit for the weight of fluorinated greenhouse gas and CO<sub>2</sub> equivalent.

---



Your air-conditioner is marked with this symbol. It means that waste electrical and electronic equipment (WEEE as in directive 2012/19/EU) should not be mixed with general household waste. Air-conditioner should be treated at an authorized treatment facility for re-use, recycling and recovery and not be disposed of in the municipal waste stream. Please contact the installer or local authority for more information.

---



This symbol printed on the batteries attached to your air-conditioner is information for end-users according to the EU directive 2006/66/EC article 20 annex II. Batteries, at their end-of-life, should be disposed of separately from general household waste. If a chemical symbol is printed beneath the symbol shown above, this chemical symbol means that the batteries contain a heavy metal at a certain concentration. This will be indicated as follows: Hg:mercury(0.0005%), Cd:cadmium(0.002%), Pb:lead(0.004%)  
Please, dispose of batteries correctly at your local community waste collection or the recycling center.



The emission sound pressure level from each Indoor and Outdoor unit is under 70 dB(A).

## contents

Safety precautions.....2	OFF TIMER operation ..... 17
Tips for effective operation .....6	ON TIMER operation ..... 18
Name of each part and its function.....7	SLEEP TIMER + ON TIMER operation ..... 18
Remote control .....9	ON TIMER + OFF TIMER operation ..... 19
Operation failure with the remote control.....9	ALLERGEN CLEAR operation ..... 19
Temporary run operation .....9	WEEKLY TIMER operation .....20
Installing two air-conditioners in the same room.....10	HIGH POWER/ECO operation .....24
Child lock.....10	NIGHT SETBACK operation.....25
Airflow range setting .....11	SILENT operation.....25
Operation and display section for remote control .....12	MENU function
Current time setting .....13	Display brightness adjustment.....26
AUTO mode operation .....13	SELF CLEAN operation.....27
Temperature adjustment during AUTO mode...14	PRESET operation .....27
FAN SPEED .....14	Maintenance .....28
COOL/HEAT/DRY/FAN mode operation .....15	Proper installation.....30
Air-conditioner operation temperature range ....15	Troubleshooting .....30
Characteristics of HEAT mode operation.....15	Notice .....31
Airflow direction adjustment.....16	Contact your dealer .....32
3D AUTO operation .....16	Auto restart function .....32
SLEEP TIMER operation .....17	About the multiple air-conditioners .....32
	Self diagnosis function.....33
	DRED .....34

# Safety precautions

- Before starting to use the system, please read these “Safety precautions” carefully to ensure proper operation of the system.
- When you have read this user’s manual, please keep it safely. If someone else takes over as user, make sure that the manual is also passed on to the new user.





 <b>WARNING</b>	Indicates a potentially hazardous situation which, if not avoided, can result in serious consequences such as death or severe injury.
 <b>CAUTION</b>	Indicates a potentially hazardous situation which, if not avoided, can result in personal injury or property damage.

Please observe these precautions with great care, since they are essential to your safety.

- Symbols which appear frequently in the text have the following meaning:

	Strictly prohibited		Observe instructions with great care		Provide proper earthing
---	---------------------	---	--------------------------------------	---	-------------------------

## ■ Safety precautions in handling air conditioners with flammable refrigerants

	<b>This equipment uses flammable refrigerants. If the refrigerant is leaked, together with an external ignition source, there is a possibility of ignition.</b>		<b>There is information included in the user’s manual and/or installation manual.</b>
	<b>The user’s manual should be read carefully.</b>		<b>A service personnel should be handling this equipment with reference to the installation manual.</b>

### **WARNING**

- |  |  |
|--|--|
| <ul style="list-style-type: none"> <li>• Strict compliance of the domestic laws must be observed when disposing the appliance.</li> <li>• Do not use means to accelerate the defrosting process or to clean, other than those recommended by the manufacturer.</li> <li>• The appliance shall be stored in a room without continuously operating ignition sources (for example: open flames, an operating gas appliance or an operating electric heater).</li> <li>• Do not pierce or burn.</li> </ul> | <ul style="list-style-type: none"> <li>• Be aware that refrigerants may not contain an odour.</li> <li>• The appliance shall be stored in a well-ventilated area where the room size corresponds to the room area as specified for operation.</li> <li>• The staff in servicing operations must hold the national qualification or other relevant qualifications.</li> <li>• The indoor unit shall be stored in a room that has a minimum area of 4.0m<sup>2</sup>.</li> </ul> |
|--|--|

## ■ INSTALLATION PRECAUTIONS

### ⚠ WARNING



- **The system is for domestic and residential use.**

If used in severe environments, such as an engineering workplace, the equipment may function poorly.



- **The system must be installed by your dealer or a qualified installer.**

It is not advisable to install the system by yourself, as faulty handling may cause leakage of water, electric shock or fire.

### ⚠ CAUTION



- **Do not install it where flammable gas may leak.**

Gas leaks may cause fire.



- **Make sure that an earth leakage breaker is installed.**

If you do not install an earth leakage breaker, you may get an electric shock.

- **Make sure to install the drain hose properly so that all the water is drained out.**

Improper installation may lead to water drop in the room resulting in wet furniture.



- **Make sure that the system has been properly earthed.**

Earth wire should never be connected to a gas pipe, water pipe, lightning conductor or telephone earth wire. Improper installation of the earth wire may cause an electric shock.

## ■ Safety precautions

### ■ OPERATION PRECAUTIONS

#### ⚠ WARNING



- **Children shall not play with the air-conditioner.**
- **Do not expose yourself to the cooling air for a long period.**  
This could affect your physical condition and cause health problems.

- **Cleaning and user maintenance shall not be made by children without supervision.**
- **Do not insert anything into the air outlet.**  
This may cause injury, as the internal fan rotates at high speed.



- **This air-conditioner can be used by children aged from 8 years and above and people with reduced physical, sensory or mental capabilities or lack of experience and knowledge, if they have been given supervision or instruction concerning use of the air-conditioner in a safe way and understand the hazards involved.**
- **Store the remote control out of reach of children.**  
Failure to observe this may result in the batteries being swallowed or other accidents.

#### ⚠ CAUTION



- **Only use approved fuses.**  
Use of steel or copper wire instead of an approved fuse is strictly prohibited, as it may cause a breakdown or fire.
- **Do not handle the switches with wet hands.**  
This may cause an electric shock.
- **Do not swing from the indoor unit.**  
If the indoor unit falls down, you may get injured.
- **Do not place a flammable insecticide or paint spray near the air-conditioner, nor spray it directly on the system.**  
This may result in a fire.
- **Do not expose any combustion appliance directly to the air stream of the air-conditioner.**  
The combustion appliance may malfunction.
- **Do not wash the air-conditioner with water.**  
This could cause an electric shock. Using a high pressure washer may cause damage to the aluminum fins, resulting in performance decrement.

- **Do not use for preservation of food, plants or animals, precision devices or works of art.**  
The system is only intended for use in ordinary domestic rooms. Any other use of the system may damage the quality of food, etc.
- **Do not place anything containing water, like vases, on top of the unit.**  
Water entering the unit could damage the insulation and therefore cause an electric shock.
- **Do not install the air-conditioner where the airflow direction is aimed directly at plants or animals.**  
This will damage their health.
- **Do not sit on the outdoor unit nor put anything on it.**  
If the unit falls down or things drop from it, people could get hurt.
- **After a long period of use, check the unit's support structure regularly.**  
If you do not repair any damage right away, the unit may fall down and cause personal injury.

## ■ Safety precautions

### ⚠ CAUTION



- **Do not touch the aluminum fins on the heat exchanger.**

It may result in injury.

- **Do not place household electrical appliances or household items underneath the indoor or outdoor units.**

Condensation falling from the unit may stain objects and cause accidents or electrical shock.

- **Do not operate the system without the air filter.**

It can cause malfunction of the system due to clogging of the heat exchanger.

- **Do not shut off the power source immediately after stopping the operation.**

Wait at least 5 minutes, otherwise there is a risk of water leakage or breakdown.

- **Do not control the system with main power switch.**

It can cause fire or water leakage. In addition, the fan can start unexpectedly, which can cause personal injury.

- **Do not pour liquid into the unit and do not put water container on the unit.**

Water entering the unit could damage the insulation and therefore cause an electric shock.



- **If you operate air-conditioner together with a combustion appliance, you must regularly ventilate the indoor air.**

Insufficient ventilation may cause accidents due to oxygen deficiency.

- **Stand firmly on a stepladder or other stable object when removing the inlet panel and filters.**

Failure to observe this may result in injury through insecure objects toppling over.

- **When you clean air-conditioner, stop the unit and turn off the power source.**

Never open the panel while the internal fan is rotating.

- **Do not place objects near the outdoor unit or allow leaves to gather around the unit.**

If there are objects or leaves around the outdoor unit, small animals may enter unit and contact electrical parts and may cause a break-down, smoke or fire.

- **Contact your dealer to clean inside the indoor unit, do not attempt to do by yourself.**

The use of a non-approved detergent or improper washing method may damage the unit's plastic components and cause leaks. Damage, smoke, or fire may also happen if the detergent comes in contact with electrical parts or the unit's motor.

- **Stop the unit and turn off the power if you hear thunder or there is a danger of lightning.**

It may damage the unit.

- **If the power cable becomes damaged, contact your dealer or a qualified installer.**

If it is not replaced, it may cause a breakdown or fire.

## ■ Safety precautions

### ■ PRECAUTIONS FOR RELOCATION OR REPAIRS

#### WARNING



- **Do not perform any repairs or modifications by yourself. Consult the dealer if the unit requires repair.**

If you repair or modify the unit, it can cause water leaks, electric shocks or fire.



- **Consult your dealer for repairs.**  
Wrong repairs could cause an electric shock, fire, etc.
- **In case the air-conditioner is relocated elsewhere, contact your dealer or a qualified installer.**  
Faulty installation may cause water leakage, electric shock, fire, etc.
- **If you notice anything abnormal (smell of burning, etc.), stop the system, turn off the power source and consult your dealer.**

Continued use of the system in abnormal circumstances can result in malfunctioning, electric shock, fire, etc.

- **If the air-conditioner fails to cool or warm the room, it may have a refrigerant leakage. Contact your dealer.**

**If refrigerant needs to be added, check with your dealer for proper instructions.**

If the refrigerant comes in contact with the bare skin, it may cause cold injury.

If the refrigerant gas is inhaled excessively, it may cause deterioration of nerve function like dizziness and headache, or deterioration of heart function like irregular heartbeat and heart palpitation temporarily. If refrigerant unexpectedly leaks from the unit onto a fan heater, stove, hotplate or other heat source, harmful gases could be generated.

## Tips for effective operation

■ Please observe the following for the most economic and comfortable use of your unit.

- **Set a suitable room temperature.**  
Excessively high or low temperatures are not good for your health and waste of electricity.
- **Clean the filters frequently.**  
Clogged filters may block the airflow and cause less efficient operation.  Page 28
- **Avoid direct sunlight and draught.**  
Cut out direct sunlight by drawing the curtains or blinds when cooling. Keep windows and doors shut, except when ventilating.
- **Adjust the airflow direction properly.**  
Adjust the up/down and left/right airflow to ensure a steady room temperature.
- **Operate the unit only when needed.**  
Use the timer properly to operate the unit only when needed.
- **Keep heat source away when cooling.**  
Keep heat sources out of the room as much as possible.



# Name of each part and its function

## INDOOR UNIT

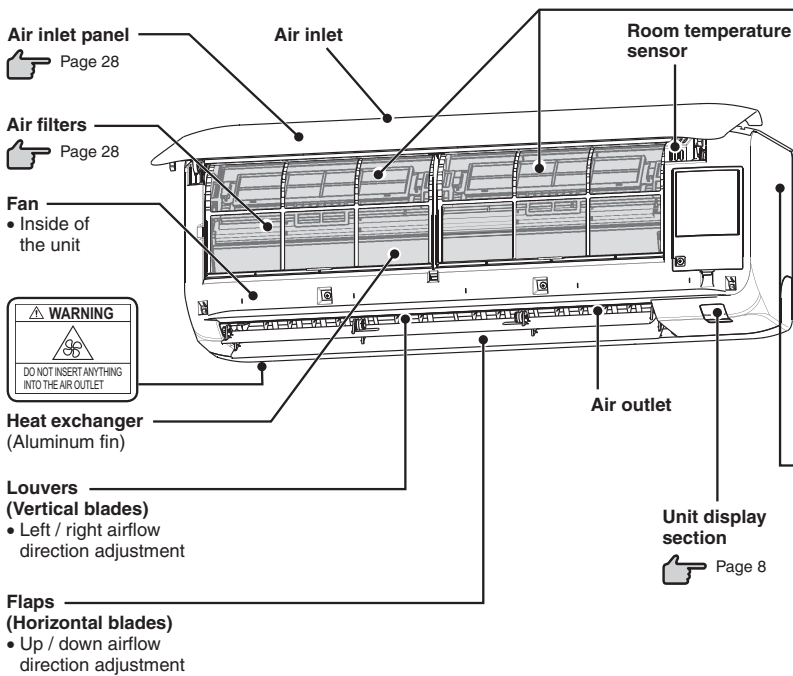

### Air-cleaning filter

- Allergen clear filter (Light orange)
- Photocatalytic washable deodorizing filter (Orange)

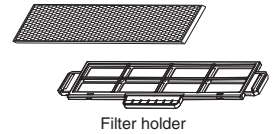
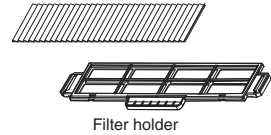

SPLIT TYPE ( INDOOR UNIT )  
 MODEL \_\_\_\_\_  
 SERVICE CODE \_\_\_\_\_  
 POWER SUPPLY \_\_\_\_\_

Model name

## OUTDOOR UNIT

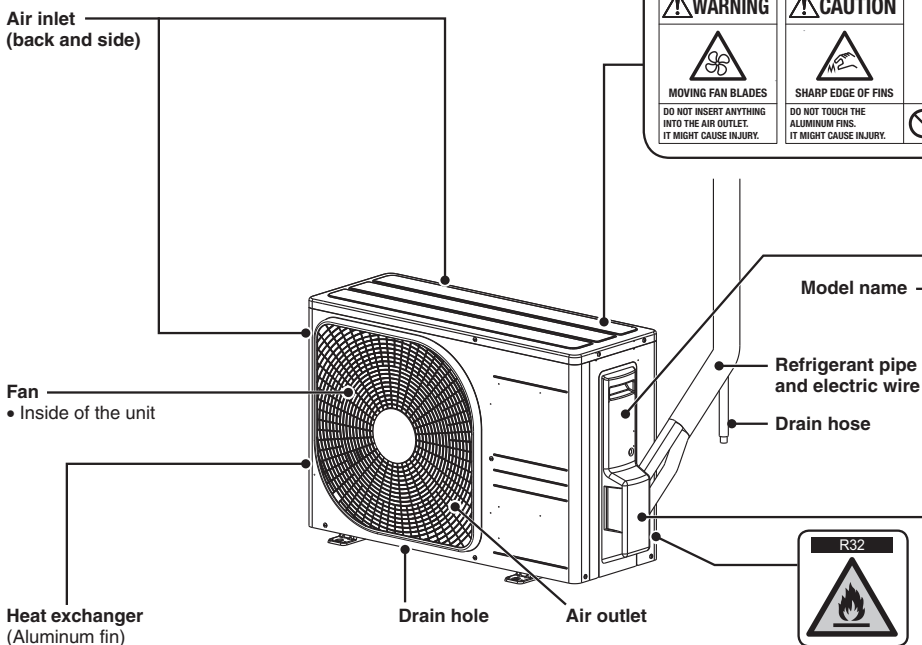

<p><b>WARNING</b></p> <p><b>MOVING FAN BLADES</b></p> <p>DO NOT INSERT ANYTHING INTO THE AIR OUTLET. IT MIGHT CAUSE INJURY.</p>	<p><b>CAUTION</b></p> <p><b>SHARP EDGE OF FINS</b></p> <p>DO NOT TOUCH THE ALUMINUM FINS. IT MIGHT CAUSE INJURY.</p>	<p><b>DO NOT STEP ON TOP OF THIS UNIT. IT MIGHT CAUSE INJURY.</b></p>
---	--	---

SPLIT TYPE ( OUTDOOR UNIT )  
 MODEL \_\_\_\_\_  
 SERVICE CODE \_\_\_\_\_  
 POWER SUPPLY \_\_\_\_\_

Don't touch the terminal block.

Don't touch refrigerant pipings and connections.

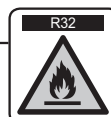

This equipment uses flammable gas.

Page 2

\* The appearance varies by models

# Name of each part and its function

## Unit display section

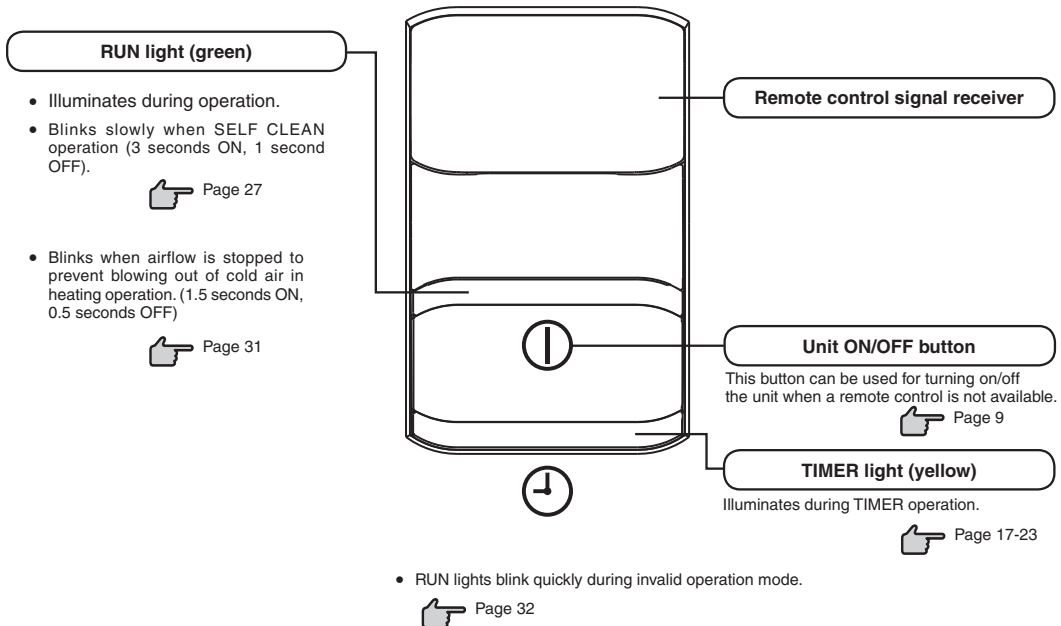

## Accessories



Remote control



Remote control holder

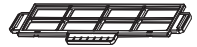
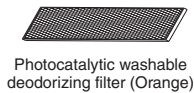
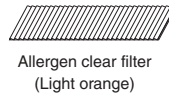
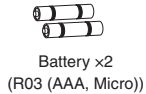

Filter holder x2

### NOTE

#### • Buzzer sound for remote control

**Buzzer sound (PipPip) is produced when** preset temperature is set to 24 °C or, AUTO operation mode is selected or, automatic airflow is selected.

#### **Buzzer sound (Pip) is produced when**

air-conditioner is turned off by pressing ON/OFF button (except SELF CLEAN mode).

#### Airflow setting

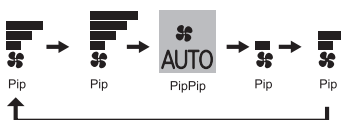

#### Preset temperature



# Remote control

## Setting the batteries

**1** Pull out the cover.

**2** Insert new batteries. R03 (AAA, Micro) x2

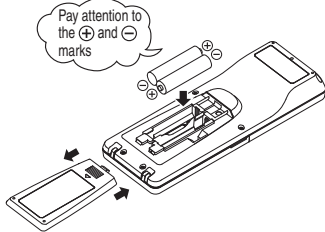

**3** Close the cover.

**4** Press the ACL switch with the tip of a ballpoint pen.

- Set the current time.

Page 13 Step 2

### NOTE

- Do not use old and new batteries together.
- Remove the batteries when the remote control is not used for a long period.
- The recommended effective period of a battery conforming to JIS or IEC should be 6 to 12 months with normal use. If used longer, or when an unspecified battery is used, liquid may leak from the battery, causing the remote control to malfunction.
- The recommendable effective period is printed on the battery. This may be shorter due to manufacturing time to the unit. However, the battery may still be in working order after expiry of its nominal life.

■ When the display shows any abnormal condition, press the ACL switch with the tip of a ballpoint pen.

## Using the remote control holder

The remote control can be attached to a wall or pillar by using the remote control holder. Before installing the remote control, check that the air-conditioner receives the signals properly.

For installing or removing the remote control, move it up or down in the holder.

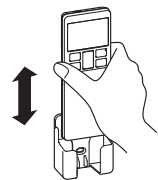

The following cases show exhausted batteries. Replace old batteries with new ones.

- Receiving beep is not emitted when a signal is transmitted.
- Display fades away.

## Warning note for remote control

### ⊘ Strictly prohibited

- |   |  |  |
|---|--|--|
| <ul style="list-style-type: none"> <li>• Do not take remote control near high temperature places, such as an electric heating carpet or a stove.</li> </ul> | <ul style="list-style-type: none"> <li>• Do not leave the remote control exposed to direct sunlight or other strong lighting.</li> </ul> | <ul style="list-style-type: none"> <li>• Do not drop the remote control. Handle with care.</li> </ul>                |
| <ul style="list-style-type: none"> <li>• Do not put any obstructing obstacles between the remote control and the unit.</li> </ul>                           | <ul style="list-style-type: none"> <li>• Do not spill any liquid on the remote control.</li> </ul>                                       | <ul style="list-style-type: none"> <li>• Do not place heavy objects on the remote control, or step on it.</li> </ul> |

# Operation failure with the remote control

• Are the batteries running down?



“Setting the batteries” above.

Replace the batteries with new ones and retry the operation.

• If the operation fails, operate the unit with temporary run operation function.

Contact your dealer to have the remote control checked.



Below

# Temporary run operation

- The unit ON/OFF button on the unit operates ON/OFF temporarily when the remote control is not used.

### Operation program

- OPERATION MODE : AUTO
- FAN SPEED : AUTO
- AIR FLOW : AUTO

- Operation starts by pressing the unit ON/OFF button; it stops if you press the button again.



Unit ON/OFF button

### NOTE

- Do not keep pressing the unit ON/OFF button down for 5 seconds or more. (Pressing it 5 seconds or more sets the forced cooling operation used during servicing or when relocating the air-conditioner.)

# Installing two air-conditioners in the same room

- When two air-conditioners are installed in the same room, use this setting when the two air-conditioners are not operated with one remote control. Set the remote control and indoor unit.

## Setting the remote control

- 1** Pull out the cover and take out batteries.
- 2** Disconnect the switching line next to the battery with wire cutters.

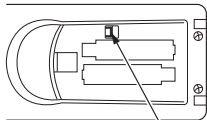

Disconnect

- 3** Insert batteries. Close the cover.

## Setting an indoor unit

- 1** Turn off the power source and turn it on after 1 minute.
- 2** Point the remote control (that was set according to the procedure described on the left side) at the indoor unit and send a signal by pressing the ACL switch on the remote control.

Since the signal is sent in about 6 seconds after the ACL switch is pressed, point the remote control at the indoor unit for some time.

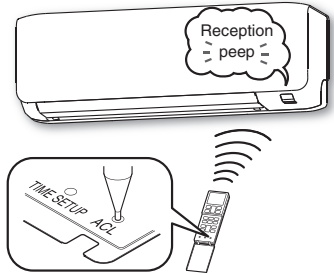

- 3** Check that the reception buzzer sound "peep" is emitted from the indoor unit.

At completion of the setting, the indoor unit emits a buzzer sound "peep". (If no reception sound is emitted, start the setting from the beginning again.)

# Child lock

- This function locks the remote control operation to prevent an operation error.

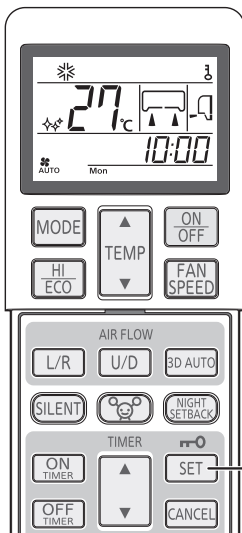

- 1** Press the SET button for 3 seconds or more.

is displayed. When Child lock is set, only the ON/OFF button can be operated.

### Releasing procedure

Turn off the light by pressing the SET button for 3 seconds or more.

### NOTE

- While Child lock is set, the settings of temperature, fan speed and airflow direction cannot be changed. To change the settings, reset Child lock.
- Child lock will not function during ALLERGEN CLEAR operation.

# Airflow range setting

- Take the air-conditioner location into account and adjust the left/right airflow range to maximize air-conditioning.

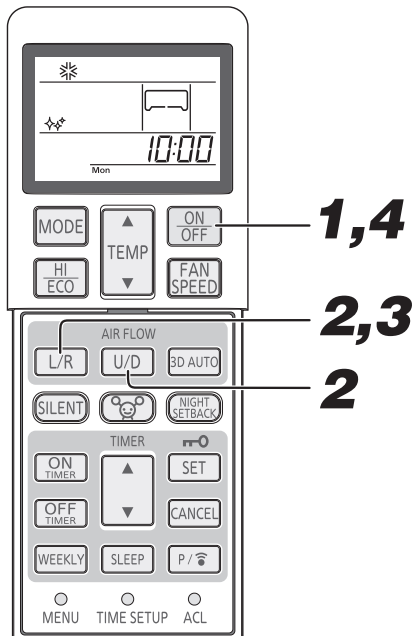

**1** If the air-conditioner is running, press the ON/OFF button to stop.

The airflow range setting cannot be made while the unit is running.

**2** Press the AIR FLOW U/D (UP/DOWN) button and the AIR FLOW L/R (LEFT/RIGHT) button together for 5 seconds or more.

The airflow range setting display illuminates.

**3** Setting the airflow range.

Press the AIR FLOW L/R (LEFT/RIGHT) button and adjust to the desired location. Each time the AIR FLOW L/R (LEFT/RIGHT) button is pressed, the display is switched in the order of:



**4** Press the ON/OFF button.

The air-conditioner's airflow range is set.

Press within 60 seconds of setting the airflow range (while the airflow range setting display illuminates).

## Air-conditioner installation location and airflow range

The diagram below indicates the airflow ranges corresponding to the air-conditioner's installation location. Consider your room's layout and set the airflow range to maximize air-conditioning.

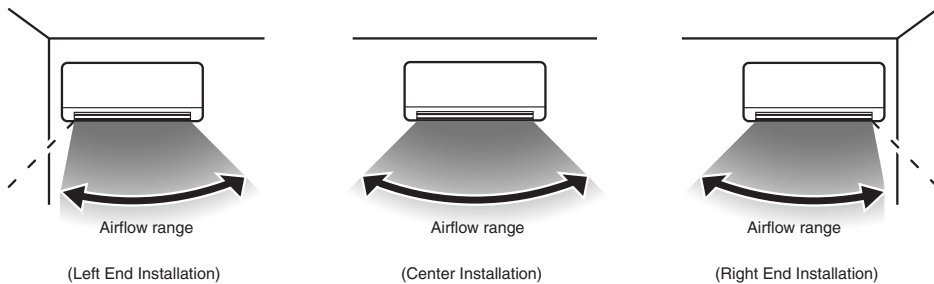

### NOTE

- Once the airflow range setting is configured, it is stored in the air-conditioner even if the power source is turned off. To change the airflow range setting, set range again with the remote control.
- During the operation, an airflow range setting cannot be set.
- When the air-conditioner is installed at the location within 50 cm from the wall, it is recommended to change the airflow range setting to "Right End Installation" or "Left End Installation".

# Operation and display section for remote control

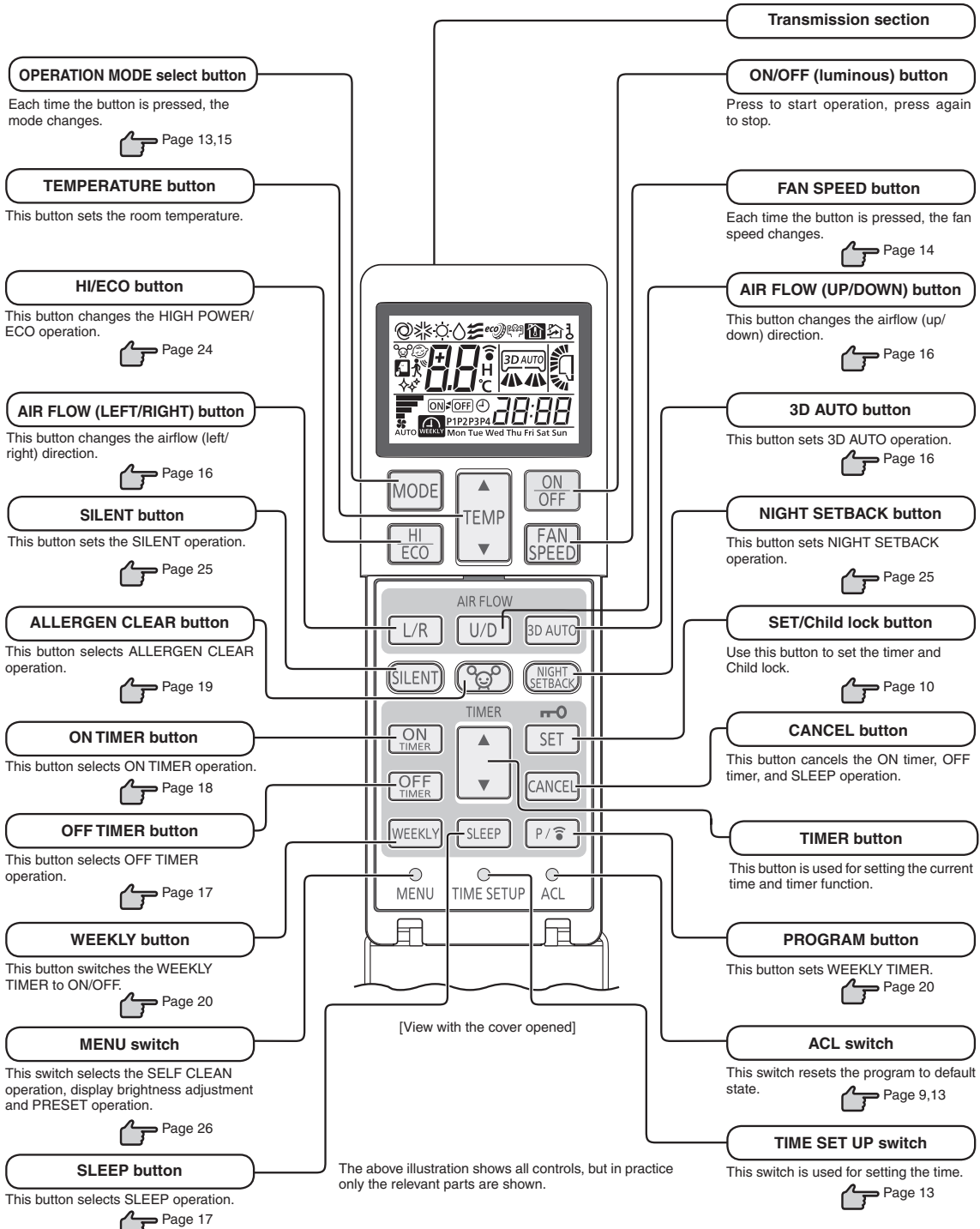

**OPERATION MODE select button**  
 Each time the button is pressed, the mode changes.  
 ➔ Page 13,15

**TEMPERATURE button**  
 This button sets the room temperature.

**HI/ECO button**  
 This button changes the HIGH POWER/ECO operation.  
 ➔ Page 24

**AIR FLOW (LEFT/RIGHT) button**  
 This button changes the airflow (left/right) direction.  
 ➔ Page 16

**SILENT button**  
 This button sets the SILENT operation.  
 ➔ Page 25

**ALLERGEN CLEAR button**  
 This button selects ALLERGEN CLEAR operation.  
 ➔ Page 19

**ON TIMER button**  
 This button selects ON TIMER operation.  
 ➔ Page 18

**OFF TIMER button**  
 This button selects OFF TIMER operation.  
 ➔ Page 17

**WEEKLY button**  
 This button switches the WEEKLY TIMER to ON/OFF.  
 ➔ Page 20

**MENU switch**  
 This switch selects the SELF CLEAN operation, display brightness adjustment and PRESET operation.  
 ➔ Page 26

**SLEEP button**  
 This button selects SLEEP operation.  
 ➔ Page 17

**Transmission section**

**ON/OFF (luminous) button**  
 Press to start operation, press again to stop.

**FAN SPEED button**  
 Each time the button is pressed, the fan speed changes.  
 ➔ Page 14

**AIR FLOW (UP/DOWN) button**  
 This button changes the airflow (up/down) direction.  
 ➔ Page 16

**3D AUTO button**  
 This button sets 3D AUTO operation.  
 ➔ Page 16

**NIGHT SETBACK button**  
 This button sets NIGHT SETBACK operation.  
 ➔ Page 25

**SET/Child lock button**  
 Use this button to set the timer and Child lock.  
 ➔ Page 10

**CANCEL button**  
 This button cancels the ON timer, OFF timer, and SLEEP operation.

**TIMER button**  
 This button is used for setting the current time and timer function.

**PROGRAM button**  
 This button sets WEEKLY TIMER.  
 ➔ Page 20

**ACL switch**  
 This switch resets the program to default state.  
 ➔ Page 9,13

**TIME SET UP switch**  
 This switch is used for setting the time.  
 ➔ Page 13

The above illustration shows all controls, but in practice only the relevant parts are shown.

**Display in OFF status**



The current time, day of the week, and present OPERATING MODE are displayed while the air-conditioner is turned off.

**Transmission procedure**

When each button on the remote control is pressed – with the remote control pointing towards the air-conditioner unit, a signal is transmitted. When the air-conditioner receives the signal correctly, it will beep.

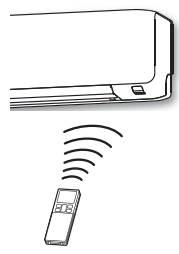

# Current time setting

- When inserting the batteries, the current time is automatically set to time setting mode. Mon and 13:00 are displayed as the current time. Set a correct day of the week and time.

Example: Set to Sat 10:30.

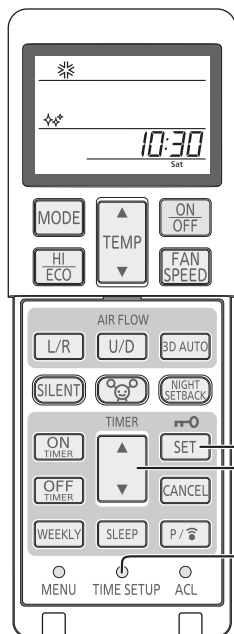

## 1

### Press the TIME SET UP switch.

Press with the tip of a ballpoint pen, etc.  
The day of the week display blinks, enabling the setting of a day of the week.

## 2

### Press the “▲ or ▼ (TIMER)” button.

(Set to Sat)

## 3

### Press the SET button.

The day of the week display changes from blinking to steady lighting, completing the setting of a day of the week, and the time display blinks. Make sure to press the button within 60 seconds from the last operation in step 2, otherwise the day of the week will not be set.

## 4

### Press the “▲ or ▼ (TIMER)” button.

(Set to 10:30)

## 5

### Press the SET button.

The time display changes from blinking to steady lighting and the setting is complete. Make sure to press the button within 60 seconds from the last operation in step 4, otherwise the time will not be set.

### NOTE

- The timer operation works based on the time clock, so set it correctly.
- The remote control data will be reset when the present time is set.
- When the battery of the remote control is replaced or the ACL switch is pressed, the remote control will be set to the initial state. Since the WEEKLY TIMER program is not set in the initial state, set the program according to the setting procedure.

# AUTO mode operation

- Automatically selects the operation mode (COOL, HEAT) depending on the room temperature when switched on.

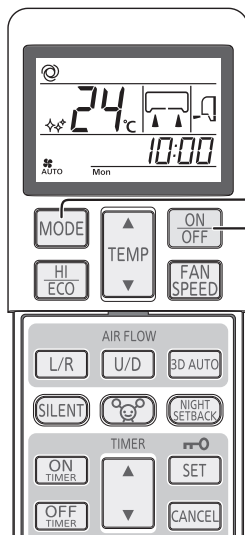

## 1

### Press the MODE button.

The mode changes whenever the button is pressed.  
Set to ☉.

## 2

### Press the ON/OFF button.

To stop:

Press the ON/OFF button.

### NOTE

- In case air is not blowing out during the operation.

➡ Page 31

- If you do not want the AUTO mode program, change to COOL, HEAT or FAN instead of AUTO.

➡ Page 15

- Airflow direction adjustment procedure.

➡ Page 16

# Temperature adjustment during AUTO mode

- Default preset temperature during AUTO mode is 24°C for both cooling and heating mode. However, it can be adjusted (Minimum 18°C, Maximum 30°C) using ▲ button or ▼ button.

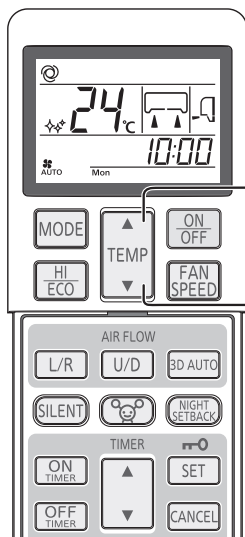

**1** Press the “▲ or ▼ (TEMP)” button.

**When it is a little cold**  
Press the ▲ button.

- Each time the ▲ button is pressed, the switch over occurs in the following order 18 → 19 → ..... 23 → 24 → 25 ..... → 30.
- When 30 is indicated, even if the ▲ button is pressed, the indicator does not change.

**When it is a little hot**  
Press the ▼ button.

- Each time the ▼ button is pressed, the switch over occurs in the following order 30 → 29 → ..... 25 → 24 → 23 ..... → 18.
- When 18 is indicated, even if the ▼ button is pressed, the indicator does not change.

# FAN SPEED

- The FAN SPEED can be set without DRY mode.

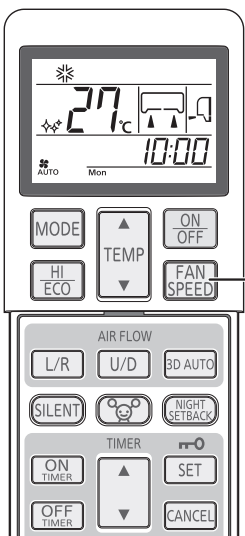

**1** Press the FAN SPEED button.

Each time the button is pressed, the fan speed changes.

Operation capacity by your choice	FAN SPEED
Set automatically by microcomputer	AUTO
Silent operation	ULo
Energy-saving operation	Lo
Standard operation	Me
Powerful operation with high capacity	Hi

**NOTE**

- When FAN SPEED is changed from Hi to Lo or ULo, the sound of refrigerant may be heard.



# COOL/HEAT/DRY/FAN mode operation

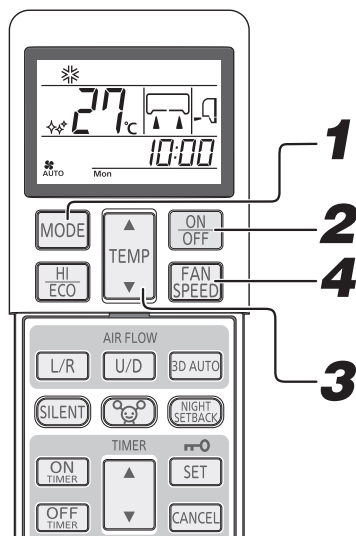

Airflow direction adjustment procedure. Page 16

## NOTE

- In case air is not blown out, when starting the heating operation. Page 31
- The operation mode can also be set or changed when the air-conditioner is not in operation.

### 1

#### Press the MODE button.

Set to a required mode.

☀ (COOL), ☀ (HEAT), ☹ (DRY), ⚙ (FAN)

### 2

#### Press the ON/OFF button.

### 3

#### Press the TEMP button.

Press ▲ or ▼ button for the preferred temperature.

Recommendation

COOL	HEAT	DRY	FAN
26 °C - 28 °C	22 °C - 24 °C	24 °C - 26 °C	—

### 4

#### Press the FAN SPEED button

Set the fan speed as preferred.

A fan speed cannot be set under Dry operation.

To stop:

Press the ON/OFF button.

# Air-conditioner operation temperature range

- Use within the following operational range. Operating outside of this range may result in the protection devices being activated, preventing the unit from working.

	COOL mode operation	HEAT mode operation
Outside temperature	Approximately -15 to 46 °C	Approximately -15 to 24 °C
Inside temperature	Approximately 18 to 32 °C	Approximately 10 to 30 °C
Inside humidity	Below approximately 80% The long-term use of the unit with a humidity level exceeding 80% may result in condensation forming on the surface of the indoor unit, leading to water drops.	

# Characteristics of HEAT mode operation

## Mechanism and capacity of HEAT mode operation

- The unit draws heat from the cold outside air, transfers it to indoors and heats the room. As a characteristic of heat pump system, the heating capacity reduces when the outside air temperature gets colder.
- It may take some time to supply hot air after turning on the air-conditioner.
- If the outside temperature becomes extremely low, it would be better to use an additional source of heating.

## Defrosting

If the outside temperature becomes low and humidity is high, the heat exchanger in the outdoor unit may frost over, which prevents efficient heating.

**If this happens, the automatic defrost function is activated and the heating operation stops for 5 to 15 minutes during defrosting.**

- Both indoor and outdoor fans stop and the RUN light blinks slowly (1.5 seconds ON, 0.5 seconds OFF) during defrosting.
- The outdoor unit may release some steam during defrosting. This is to help the defrosting process and is not a defect.
- The HEAT operation resumes as soon as defrosting has been completed.

# Airflow direction adjustment

- Up/down direction can be adjusted with the AIR FLOW U/D (UP/DOWN) button on the remote control. Every time you press this button, the mode changes as follows:

Change on AIR FLOW (UP/DOWN) mode.

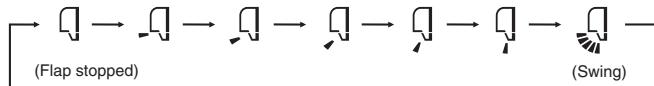

- Left/right direction can be adjusted with the AIR FLOW L/R (LEFT/RIGHT) button on the remote control. Every time you press this button, the mode changes as follows:

Change on AIR FLOW (LEFT/RIGHT) mode.

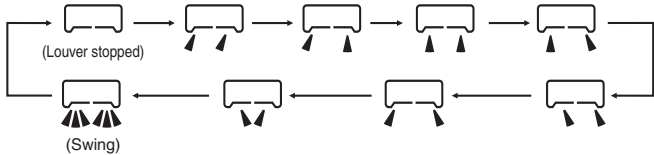

## NOTE

- The actual position of the flap and louver may differ from the display shown.

## NOTE FOR HEATING OPERATION

- When heating operation starts, the flap and louver direction is fixed at the horizontal / center position in order to avoid cold draft. It returns to the set position when the warm air supply is started.
- The flap and louver direction will be controlled to the horizontal/center position when the room temperature reaches the set temperature and compressor stops or when defrosting is in operation.
- The airflow direction cannot be set during the period mentioned above. Change the airflow direction settings after the warm air is supplied and the flap/louver goes to the set position.

## Memory flap (Flap or louver stopped)

When you press the AIR FLOW (U/D or L/R) button once while the flap or louver is operating, it stops swinging at the position. Since this angle is memorized in the microcomputer, the flap or louver will automatically be set at this angle when the next operation is started.

- WARNING**  
Do not expose directly to airflow from the air-conditioner for a long time.

- CAUTION**  
When in COOL or DRY operation, do not operate for a long period with the airflow blowing straight down. Otherwise, condensation may appear on the outlet grill and drip down.
- Do not try to adjust the flaps and louvers by hand, as the control angle may change or the flap or louver may not be closed completely.

- Recommended angle of the flap when stopping

HEAT		(Slant forward blowing)
COOL, DRY		(Horizontal blowing)

# 3D AUTO operation

- Fan speed and airflow direction are automatically controlled, allowing the entire room to be efficiently air-conditioned.

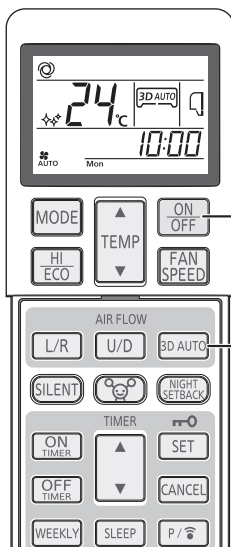

# 1

Press the ON/OFF button.

# 2

Press the 3D AUTO button.

Each time the 3D AUTO button is pressed, the display is switched in the order of:

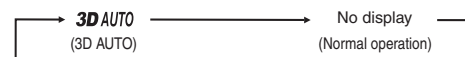

## Releasing procedure

Press the 3D AUTO button to turn off the 3D AUTO display.

## NOTE

- 3D AUTO operation is canceled when you switch the operation mode.
- If 3D AUTO operation is canceled then the airflow direction changes to that used before 3D AUTO was set.
- 3D AUTO operation can be set in AUTO, COOL, or HEAT operation mode only.

# SLEEP TIMER operation

- The unit will stop automatically after the set time lapses.

The set temperature is automatically adjusted according to the lapse time in order to avoid too much cooling or heating.  Page 19

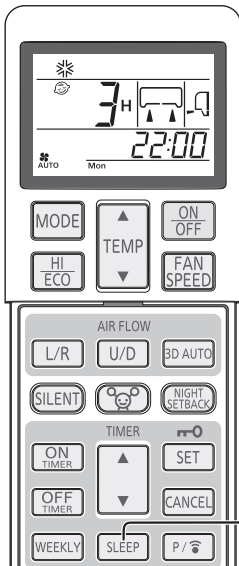

## Changing of set time

Set a new time by pressing SLEEP button.

## How to cancel

Press the CANCEL button to turn off the SLEEP display.

# 1

Press the SLEEP button.

- If it is pressed while the unit is off

SLEEP TIMER operation starts with the previous operation settings, and the air-conditioner is turned off after the set time lapses.

- If it is pressed while the unit is running

The air-conditioner is turned off after the set time lapses.

Every time the button is pressed, the display changes as follows:

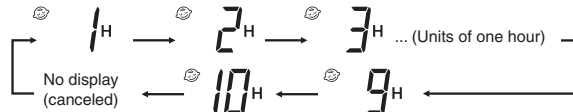

Example: You prefer it to stop after 3 hours.

Set to 3H

The timer light (yellow) is on.

- The unit stops after the set time lapses.

## NOTE

- SLEEP operation will not function during ALLERGEN CLEAR operation.
- SLEEP TIMER cannot be set simultaneously with OFF TIMER.

# OFF TIMER operation

- The unit stops automatically when the set time comes.

With the air-conditioner turned off, start the operation from Step 1. With the air-conditioner running, start from Step 2.

Example: You prefer it to stop 22:30.

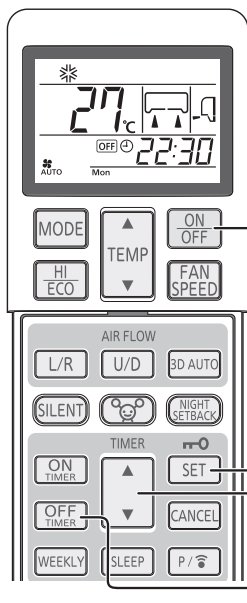

## Changing of set time

Set a new time by using the OFF TIMER button.

## How to cancel

Press the CANCEL button to turn off the timer display.

# 1

Press the ON/OFF button.

# 2

Press the OFF TIMER button.

OFF TIMER display OFF is blinking.

# 3

Press the "▲ or ▼ (TIMER)" button.

Every time the ▲ button is pressed, the display is switched in the order of:

→0:00→0:10→0:20→...→1:00→1:10→ (Units of ten minutes)

Every time the ▼ button is pressed, the display is switched in the order of:

→0:00→23:50→23:40→...→23:00→22:50→ (Units of ten minutes)

Set at 22:30.

# 4

Press the SET button.

The display changes from blinking to steady lighting and the setting is complete.

The timer light (yellow) is on.

## NOTE

- The unit stops at the end of the set period of time.
- Make sure to press the button within 60 seconds from the last operation in step 3, otherwise the setting is not completed.
- The current time is not displayed during OFF TIMER operation.
- OFF TIMER operation will not function during ALLERGEN CLEAR operation.
- Different from SLEEP TIMER operation, automatic set temperature adjustment is not done during OFF TIMER operation.

# ON TIMER operation

- Operation starts 5 to 60 minutes before the set time so that the room temperature reaches the optimum temperature at the set time.  Page 19  
ON TIMER operation can be set regardless of whether the air-conditioner is running or not.

Example: When the preferred room temperature is required at 8:00.

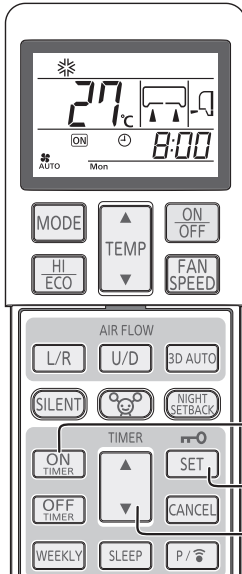

## 1 Press the ON TIMER button.

ON TIMER display  is blinking.

## 2 Press the “▲ or ▼ (TIMER)” button.

Every time the ▲ button is pressed, the display is switched in the order of:

0:00 → 0:10 → 0:20 → ... → 1:00 → 1:10 → (Units of ten minutes)

Every time the ▼ button is pressed, the display is switched in the order of:

0:00 → 23:50 → 23:40 → ... → 23:00 → 22:50 → (Units of ten minutes)

Set at 8:00.

## 3 Press the SET button.

The display changes from blinking to steady lighting and the setting is complete.

The timer light (yellow) is on.

If ON TIMER setting is performed when air-conditioner is running, air-conditioner operation will stop.

### NOTE

- Operation starts 5 to 60 minutes before the set time.
- The timer light (yellow) goes out at the set time.
- Make sure to press the button within 60 seconds from the last operation in step 2, otherwise the setting is not completed.
- The current time is not displayed during ON TIMER operation.
- ON TIMER operation will not function during ALLERGEN CLEAR operation.
- If the ON/OFF button is pressed after setting the ON TIMER, the setting will be canceled.

### Changing of set time

Set a new time by using the ON TIMER button.

### How to cancel

Press the CANCEL button to turn off the timer display.

# SLEEP TIMER + ON TIMER operation

- This is the combined timer operation of SLEEP TIMER and ON TIMER.

Example: When it is required to stop after 3 hours and then start operation at 8:00, near the set temperature.

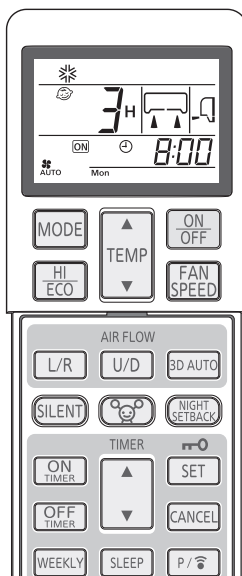

## 1 SLEEP TIMER setting

Set by the procedures on page 17.

Set to  3H

## 2 ON TIMER operation setting

Set by the above procedure mentioned in ON TIMER.

Set to  8:00

The setting of the lighting of the timer light (yellow) of this unit is complete.



- After the SLEEP TIMER set time has lapsed, the operation stops, and it starts from 5 to 60 minutes before the ON TIMER's set time.
- The timer light is turned off when ON TIMER set time comes.

### Changing of set time

Set a new time by using the SLEEP or ON TIMER button.

### How to cancel

Press the CANCEL button to turn off the timer display.

# ON TIMER + OFF TIMER operation

■ This is the combined timer operation of ON TIMER and OFF TIMER.

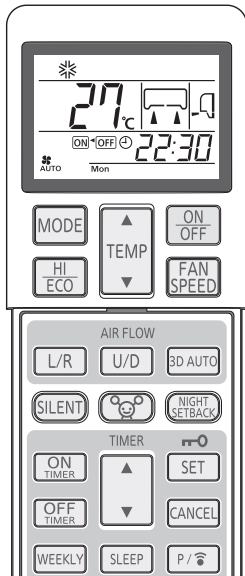

Example: Present time is 21:00. The air-conditioner running.

When it is preferred to stop at 22:30, and then start operation at 8:00, near the set temperature.

## 1 OFF TIMER operation setting

Set by the procedures on page 17.

Set to **OFF**  $\odot$  **22:30**

## 2 ON TIMER operation setting

Set by the procedures on page 18.

Set to **ON/OFF**  $\odot$  **8:00**

Timer light (yellow) on the unit will light when the setting is completed.

■ The set time will be displayed on the remote control. The display will change depending on the operational status.

- The air-conditioner stopping.  
**ON**  $\rightarrow$  **OFF**  $\odot$  First the air-conditioner starts running with ON TIMER. After the air-conditioner stops running with OFF TIMER.
- The air-conditioner running.  
**ON**  $\leftarrow$  **OFF**  $\odot$  First the air-conditioner stops running with OFF TIMER. After the air-conditioner starts running with ON TIMER.

### Changing of set time

Set a new time by using the OFF TIMER or ON TIMER button.

### How to cancel

Press the CANCEL or ON/OFF button to turn off the timer display.

### NOTE

- Timer operation can be set only for next 24 hours.

### Comfort Start-up

In ON TIMER operation, the unit starts the operation a little earlier, so that the room can approach optimum temperature at ON time. This is called "Comfort start-up".

#### • Mechanism

The room temperature is checked 60 minutes before the ON time. Depending on the temperature at that time, the operation starts 5 to 60 minutes before the timer is at ON.

• The function is available for both COOL and HEAT operation mode (including AUTO). It does not work for DRY mode.

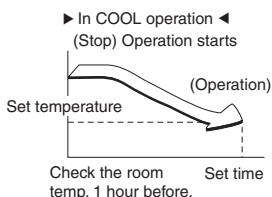

### SLEEP TIMER

When SLEEP TIMER is selected, the set temperature is automatically adjusted after a while, ensuring that the room is not too cold during cooling or too warm during heating.

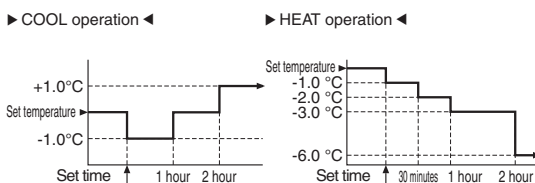

# ALLERGEN CLEAR operation

■ The power of enzymes is used to eliminate allergy-causing allergens that accumulate on the allergen clear filter.

## 1

Press the ALLERGEN CLEAR button.

To stop:

Press the ON/OFF or ALLERGEN CLEAR button.

### NOTE

- Since the room temperature may change quite a bit, it is recommended that this be used when no one is in the room. (It completes automatically in approximately 90 minutes.)
- During ALLERGEN CLEAR operation temperature, fan speed, airflow direction and timer operations settings cannot be made.
- In case of SCM multi system, ALLERGEN CLEAR control function is invalid.
- In case of SCM multi system, if ALLERGEN button is pressed by mistake, the indoor unit which received such command will stop.

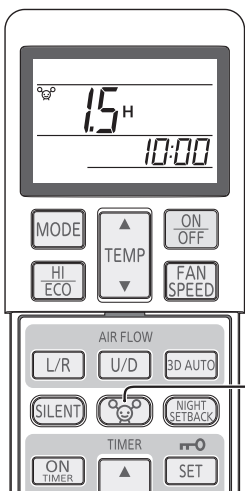

# WEEKLY TIMER operation

- Up to 4 programs with timer operation (ON TIMER / OFF TIMER) are available for each day of the week. Maximum 28 programs per week are available. Once this has been set, the timer operation will be repeated at the same programs every week unless the WEEKLY TIMER is canceled.

## Sample (At cooling season)

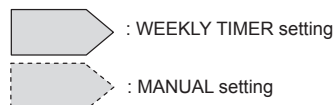

	6:00	8:00	10:00	12:00	14:00	16:00	18:00	20:00	22:00
Mon	Program 1 ON 6:00 COOL 27°C Fan: AUTO	Program 2 OFF 8:30				Program 3 ON 17:00 COOL 28°C Fan: Lo		Program 4 OFF 22:00	
Tue	Program 1 ON 5:30 COOL 27°C Fan: AUTO	Change setting AUTO 27°C Fan: Me	Program 2 OFF 12:00	ON	DRY 26°C	Program 3 ON 17:00 COOL 28°C Fan: Lo		Program 4 OFF 22:00	
Wed ~ Fri		ON	Program 1 OFF 10:00	ON	DRY 25°C	Program 2 OFF 14:00	Program 3 ON 18:00 COOL 28°C Fan: ULo	Program 4 OFF 22:00	
Sat	Program 1 ON 7:30 COOL 26°C Fan: Hi	Change setting COOL 25°C Fan: Hi	Program 2,3 No setting			Change setting COOL 28°C Fan: ULo		Program 4 OFF 22:00	
Sun		Program 2 ON 7:00 COOL 28°C Fan: Hi	OFF	Program 1 ON 12:00 COOL 26°C Fan: Hi			Program 3 ON 19:00 COOL 27°C Fan: ULo	Program 4 OFF 22:00	

## WEEKLY TIMER ON/OFF setting

- Switch the WEEKLY TIMER to ON/OFF by using the WEEKLY button.

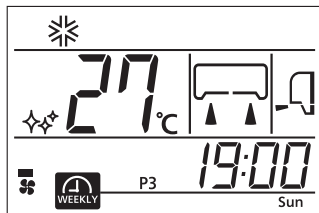

# 1

### Press the WEEKLY button.

The WEEKLY TIMER becomes effective.

Every time the WEEKLY button is pressed, the display is switched in the order of:



When the WEEKLY TIMER is set to ON, the timer light (yellow) of the air-conditioner is on.

When the battery of the remote control is replaced or the ACL switch is pressed, the remote control is set to the initial state. Since the WEEKLY TIMER program is not set in the initial state, set the program according to the setting procedure.

## NOTE

- The WEEKLY TIMER is switched to ON/OFF regardless of whether the air-conditioner is running or not.
- The ON TIMER operation of the WEEKLY TIMER is effective regardless of whether the air-conditioner is running or not. When the ON TIMER setting time is reached, the remote control operates according to the contents that are set. The remote control display is also switched to the operation contents that are set. The setting can be changed from the remote control after ON TIMER operation of the WEEKLY TIMER. The following contents can be set by the ON TIMER. Operation mode, fan speed, temperature, airflow direction, ECO, 3D AUTO, NIGHT SETBACK, SILENT. Comfort start-up is not performed for WEEKLY TIMER ON TIMER operation.
- OFF TIMER operation of the WEEKLY TIMER is effective only when the air-conditioner is running. When the time set by the OFF TIMER is reached, the air-conditioner stops.
- When multiple program numbers are set for the current day (day of the week), the operation is performed from the earliest time that is set.
- When various timers (ON TIMER, OFF TIMER, and SLEEP TIMER) are operating, the WEEKLY TIMER does not operate even if the time set in the ON TIMER or OFF TIMER is reached. The WEEKLY TIMER becomes effective after various timers are terminated.
- The ON TIMER or OFF TIMER of the same time in the same day of the week cannot be set.
- In case WEEKLY TIMER setting is not sent to the unit, TIMER light will not turn on even if the WEEKLY button is pressed and is displayed on the remote control.

## Setting mode <Individual setting>

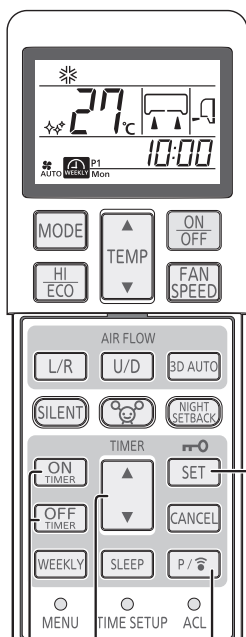

6

2,4

1

3,5

Set after setting the current day of the week and the time.

**1**

Press the PROGRAM button.

and current day of the week blink.

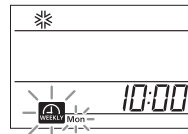

**2**

Press the “▲ or ▼ (TIMER)” button.

Select a day of the week to be reserved.  
Every time the ▲ button is pressed, the display is switched in the order of:

→ Mon → Tue → Wed → ... → Sun → Display of all of the days of the week

Every time the ▼ button is pressed, the display is switched in the order of:

→ Mon → Display of all of the days of the week → Sun → Sat → ... → Tue



**3**

Press the SET button.

The day of the week is determined and the program number blinks.

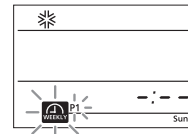

**4**

Press the “▲ or ▼ (TIMER)” button.

Select a program number.  
Every time the ▲ button is pressed, the display is switched in the order of:

→ P1 → P2 → P3 → P4

Every time the ▼ button is pressed, the display is switched in the order of:

→ P1 → P4 → P3 → P2

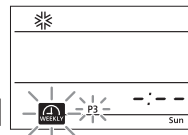

**5**

Press the SET button.

When no set contents (ON TIMER or OFF TIMER) are available, both the and timers blink.

When set contents (ON TIMER or OFF TIMER) are available, either or timer blinks.

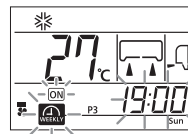
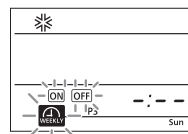

**6**

Press the ON TIMER or OFF TIMER button.

ON TIMER or OFF TIMER is determined and time display blinks.

ON TIMER is selected

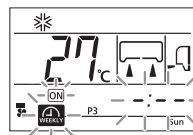

OFF TIMER is selected

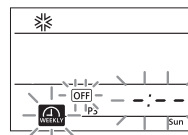

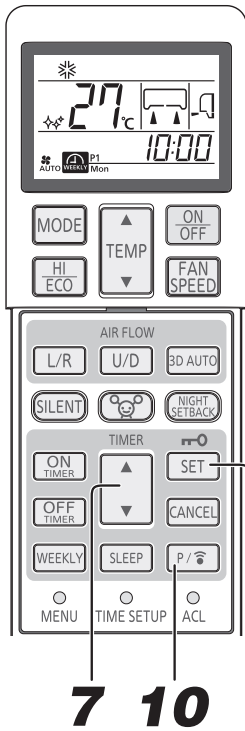

**7 10**  
**8,9,10**

**7**

**Press the “▲ or ▼ (TIMER)” button.**

Set a time.

Every time the ▲ button is pressed, the display is switched in the order of:

→0:00→0:10→0:20→...→1:00→1:10→ (Units of ten minutes)

Every time the ▼ button is pressed, the display is switched in the order of:

→0:00→23:50→23:40→...→23:00→22:50→ (Units of ten minutes)

When ON TIMER is selected, go to Step 8.  
When OFF TIMER is selected, go to Step 9.



**8**

**Set required operation contents.**

When ON TIMER is selected, operation mode, fan speed, and airflow direction can be changed and the ECO, SILENT or NIGHT SETBACK operation can be set.

**9**

**Press the SET button.**

The time is determined and and blink.

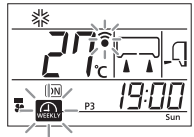

**10**

**Press the PROGRAM button or SET button.**

When the PROGRAM button is pressed, the setting is sent to the air-conditioner. Since it takes 3 seconds for transmission, point the remote control at the remote control signal receiver of the indoor unit during the period.

When the setting is received, a buzzer sound (pip, pip, pip) is emitted. When the SET button is pressed, the setting continues from Step 2.

**Setting mode <Collective setting>**

- Set the same operation contents to the same program number of all the days of the week. In Step 2 above, select “all of the days of the week”. When the contents that were individually set exist in the same program number, the contents are overwritten.

**NOTE**

- If no operation is performed for 60 seconds in setting mode, the setting changes that have been made until then become invalid and the setting mode terminates. Subsequently, and all the program numbers (P1, P2, P3 and P4) blink for 10 seconds. (This blinking can not be observed if setting mode gets terminated while setting only one program.)
- At the end of the setting mode, point the remote control at the air-conditioner and press the PROGRAM button. In this case, check that the air-conditioner emits a reception buzzer sound three times (pip, pip, pip). If the buzzer sound is not emitted, set the mode to the setting mode again by pressing the PROGRAM button and check that the buzzer sound is emitted.



## How to cancel the setting <Individual setting>

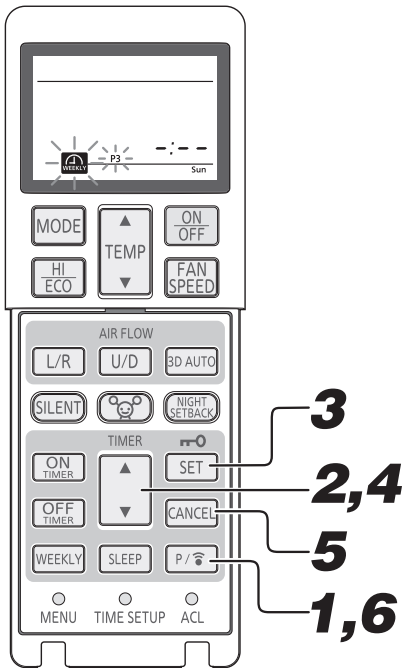

### 1 Press the PROGRAM button.

 and current day of the week blink.

### 2 Press the “▲ or ▼ (TIMER)” button.

Select a day of the week to be canceled.

### 3 Press the SET button.

The day of the week is determined and the program number blinks.

### 4 Press the “▲ or ▼ (TIMER)” button.

Select a program number to be canceled.

At cancelation operation, do not press the SET button. If the SET button is pressed, the mode is shifted to the Set mode.

### 5 Press the CANCEL button.

The setting contents of the ON or OFF TIMER are canceled and - : - - is displayed on the time display section.

### 6 Press the PROGRAM button.

When the PROGRAM button is pressed, the setting is sent to the air-conditioner.

When the setting is received, a buzzer sound (pip, pip, pip) is emitted.

The setting contents of each program are canceled. Perform the operation indicated above for each program to be canceled.

## How to cancel the setting <Collective setting>

- When the same operation contents exist in the same program number of all the days of the week, collective erase is allowed. In Step 2 above, select “all of the days of the week”. The procedure from Step 3 is the same as that indicated above.

If the operation contents have been changed or erased by individual setting after the collective setting described in page 22, causing setting content discrepancies among the days of the week, collective erase is not allowed.

### Confirm mode

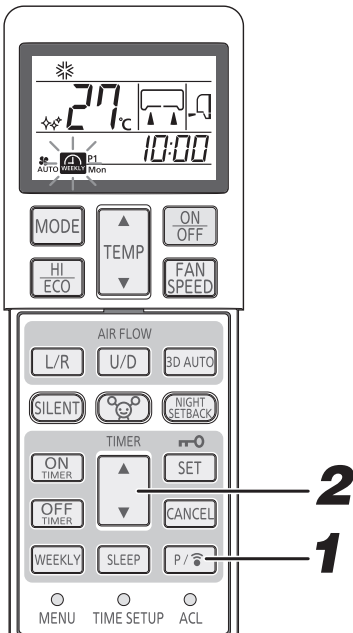

The WEEKLY TIMER setting contents can be confirmed.

### 1 Press the PROGRAM button for 3 seconds or more.

 blinks and the setting content lights.

### 2 Press the “▲ or ▼ (TIMER)” button.

Select a day of the week and a program number to be confirmed.

Display starts from the current day of the week. For the program without setting, - : - - is displayed. When the PROGRAM button is pressed in Confirm mode, a setting mode is set.

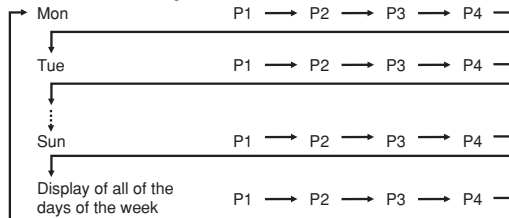

### Releasing procedure

The Confirm mode can be terminated by pressing the ON/OFF, CANCEL or SET button.

### NOTE

- If no operation is performed for 60 seconds in Confirm mode, the Confirm mode is terminated.

# HIGH POWER/ECO operation

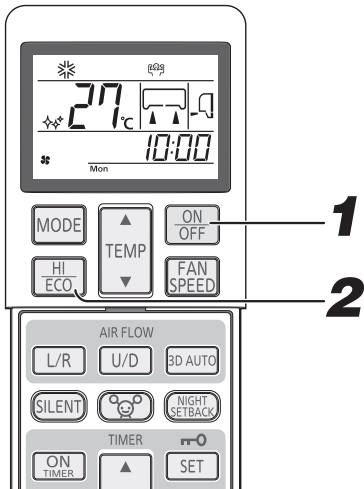

## 1

Press the ON/OFF button.

## 2

Press the HI/ECO button.

- When the operating mode is AUTO, COOL or HEAT  
Every time the HI/ECO button is pressed, the display is switched in the order of:



- When the operating mode is DRY or ON TIMER + OFF TIMER  
Every time the HI/ECO button is pressed, the display is switched in the order of:

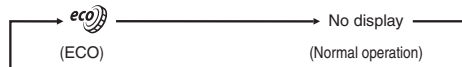

## HIGH POWER operation

Pressing the HI/ECO button intensifies the operating power and initiates powerful cooling or heating operation for 15 minutes continuously. The remote control displays and the FAN SPEED display disappears.

### NOTE

- During the HIGH POWER operation, the room temperature is not controlled. When it causes an excessive cooling or heating, press the HI/ECO button again to cancel the HIGH POWER operation.
- HIGH POWER operation is not available during the DRY and ON TIMER + OFF TIMER operations.
- When HIGH POWER operation is set after setting ON TIMER operation, HIGH POWER operation will start from the set time.
- After HIGH POWER operation, the sound of refrigerant flowing may be heard.
- When the following operations are set, HIGH POWER operation will be canceled.
  - When the HI/ECO button is pressed again. (The operation mode will be changed to the ECO operation)
  - When the operation mode is changed.
  - When it has been 15 minutes since HIGH POWER operation has started.
  - When the 3D AUTO button is pressed.
  - When the SILENT button is pressed.
  - When the NIGHT SETBACK button is pressed.
- Not operable while the air-conditioner is OFF.

## ECO operation

Pressing the HI/ECO button initiates a soft operation with the power suppressed in order to avoid an excessive cooling or heating. The unit operates 1.5°C higher than the setting temperature during cooling or 2.5°C lower than that during heating. The remote control displays and the FAN SPEED display disappears.

### NOTE

- It will go into ECO operation at the next time the air-conditioner runs in the following case.
  - When the air-conditioner is stopped by ON/OFF button during ECO operation.
  - When the air-conditioner is stopped in SLEEP or OFF TIMER operation during ECO operation.
  - When the operation is retrieved from SELF CLEAN or ALLERGEN CLEAR operation.
- When the following operations are set, ECO operation will be canceled.
  - When the HI/ECO button is pressed again.
  - When the operation mode is changed from DRY to FAN.
  - When the NIGHT SETBACK button is pressed.
- Not operable while the air-conditioner is OFF.

# NIGHT SETBACK operation

- During the cold season, the room temperature can be maintained at a comfortable level during the absence, at night, and while the room is unattended. The air-conditioner maintains the constant temperature at about 10°C.

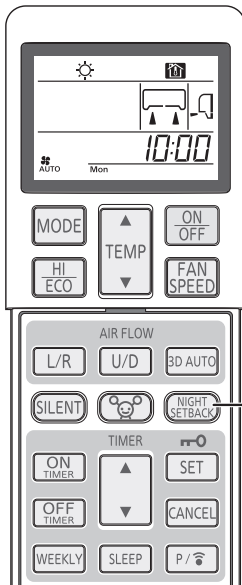

## 1

### Press the NIGHT SETBACK button.

Every time the NIGHT SETBACK button is pressed, the display is switched in the order of:



### Releasing procedure

Press the NIGHT SETBACK button or MODE button to turn off the NIGHT SETBACK display.

### NOTE

- During NIGHT SETBACK operation, the air-conditioner maintains the set temperature at about 10°C.
- During NIGHT SETBACK operation, temperature settings cannot be made.
- Since the room temperature may change quite a bit, it is recommended that this be used when no one is in the room.
- During NIGHT SETBACK operation, HIGH POWER and ECO operations cannot be set.
- When NIGHT SETBACK operation is canceled by pressing the NIGHT SETBACK button, the operation mode is reset to the mode immediately prior to the NIGHT SETBACK operation.

# SILENT operation

- When the SILENT operation is set, the unit operates more silently reducing noise from the outdoor unit. With the air-conditioner turned off, start the operation from Step 1. With the air-conditioner running, start from Step 2.

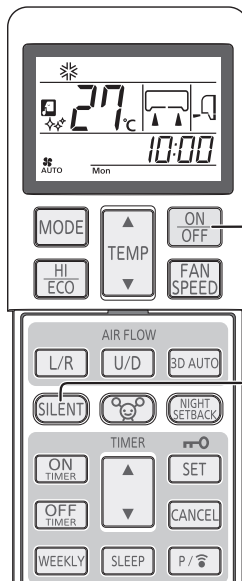

## 1

### Press the ON/OFF button.

## 2

### Press the SILENT button.

- When the operating mode is AUTO, COOL, HEAT or NIGHT SETBACK Every time the SILENT button is pressed, the display is switched in the order of:

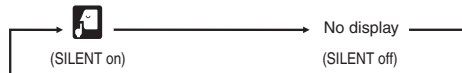

### Releasing procedure

Press the SILENT button to turn off the SILENT display.

### NOTE

- During SILENT operation, the maximum cooling and heating capacities deteriorate.
- SILENT operation will not function during DRY and FAN operation.
- In case of following operations, the air-conditioner will resume SILENT operation whenever it turns ON again.
  - ① When the air-conditioner is stopped by ON/OFF button during SILENT operation.
  - ② When the air-conditioner is stopped in SLEEP or OFF TIMER operation during SILENT operation.
  - ③ When the operation is retrieved from SELF CLEAN or ALLERGEN CLEAR operation.
- Not operable while the air-conditioner is OFF.
- The noise level of the outdoor unit may not decrease depending on the condition.
- In case of SCM multi system, SILENT control is invalid.

# MENU function

■ MENU function is used for setting the display brightness adjustment, SELF CLEAN operation and PRESET operation.

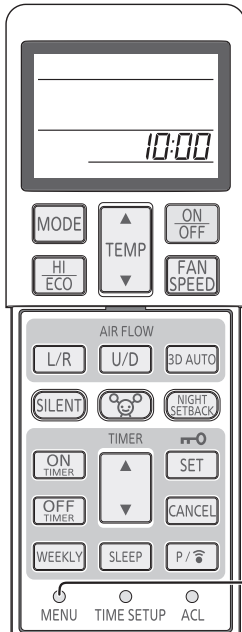

**1** Every time the MENU switch is pressed with the tip of a ballpoint pen, etc., the display is switched in order of:

## Display brightness adjustment

■ This function can be used when it is necessary to adjust the brightness of unit display.

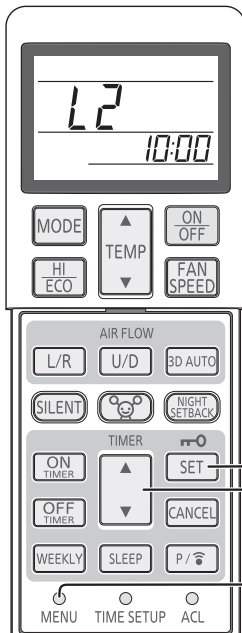

**1** Select the display brightness adjustment by pressing the MENU switch.

**2** Select the brightness level by pressing “▲ or ▼ (TIMER)” button.

**3** Press the SET button.

## SELF CLEAN operation

- SELF CLEAN operation should be run after AUTO, COOL and DRY operation to remove the moisture from inside of the indoor unit and control the growth of mold and bacteria.

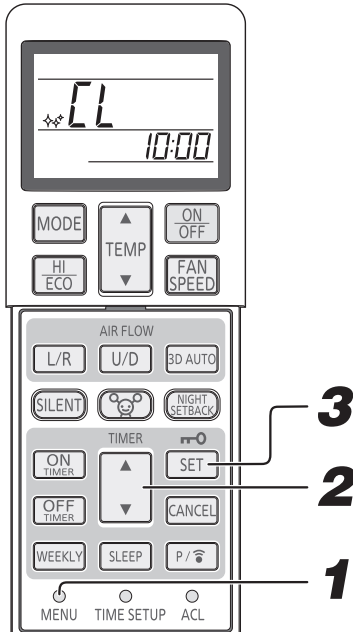

**1** Select the SELF CLEAN operation by pressing the MENU switch.

**2** Select SELF CLEAN on by pressing “▲ or ▼ (TIMER)” button.

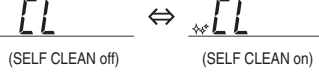

**3** Press the SET button.

### NOTE

- Two hours later, the air-conditioner stops SELF CLEAN operation automatically. To stop the air-conditioner immediately, press the ON/OFF button.
- SELF CLEAN operation is not operated after HEAT, FAN, OFF TIMER, SLEEP and ALLERGEN CLEAR operations have finished.
- The indoor unit fan runs for about two hours in SELF CLEAN operation.
- The RUN light illuminates during SELF CLEAN operation.

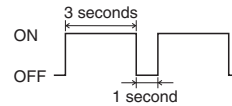

- Pressing the SLEEP button, ALLERGEN CLEAR button or NIGHT SETBACK button during SELF CLEAN operation cancels the SELF CLEAN operation and then the unit is set to SLEEP, ALLERGEN CLEAR or NIGHT SETBACK operation.
- This is not a function for removing mold, germs or grime that have already adhered to the unit.

## PRESET operation

- This operation can save the preferred setting for future operation.

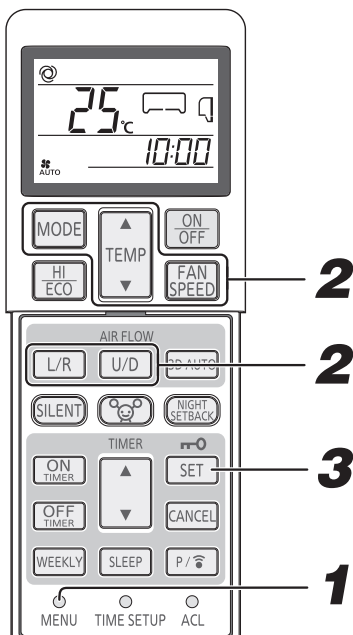

**1** Select the PRESET operation by pressing the MENU switch.

**2** Select preferred OPERATION MODE, TEMPERATURE, FAN SPEED and AIR FLOW direction.

**3** Press the SET button.

**4** When air -conditioner is operating AUTO, COOL, HEAT, DRY, FAN and NIGHT SETBACK, press MODE button 3 seconds or more. PRESET operation will start.

### NOTE

- When pressing MODE button for PRESET operation during the 3D AUTO or HIGH POWER operation, it will be canceled.
- When pressing MODE button for PRESET operation during the ECONOMY operation, it will continue.

# Maintenance

## Before maintenance

Turn off the power source.



- Do not spill any liquid to the unit.
- Do not touch the aluminum fins on the heat exchanger.
- Stand firmly on a stepladder or other stable object when removing the air inlet panel and filter.

**Do not use the following items:**

- Hot water (40°C or more)  
It may deform or discolour the unit.
- Petrol, paint thinner, benzine or cleanser, etc. It may deform or scratch the unit.

## During the operational season

### Cleaning the air filter

Standard interval is once every two week

#### 1 Remove the air filter

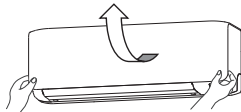

- Pull up the air inlet panel forward.
- Lightly hold the knobs both sides and lift a little to remove the panel forward.

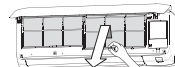

#### 2 Cleaning

If the filter is very dirty, clean it with warm water (approx. 30°C), and dry it thoroughly.

#### CAUTION

- Do not clean the filters with boiling water.
- Do not dry them over an open flame.
- Pull them out gently.



#### 3 Reinstall the air filter

- Hold firmly the filter at both sides as shown at right and insert securely.
- Operating without the air filters will make the unit dusty, and may cause damage.

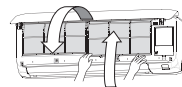

### Cleaning the unit

- Wipe the unit with a soft, dry cloth, or use a vacuum cleaner.
- If the unit is very dirty, wipe it with a cloth soaked in warm water.

### Cleaning the air inlet panel

- The panel can be washed with water. After washing with water, wipe any moisture off the panel and dry out of direct sunlight.

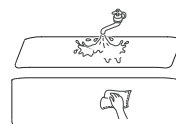

## How to open and close the air inlet panel

### Open

Place fingers at the corners on both sides of the panel and pull up the panel forward so that it will be open by about 70 degrees.

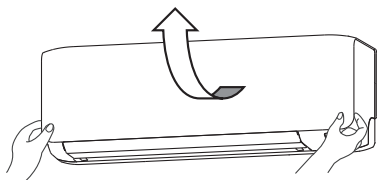

### Close

Push both corners of the panel evenly and press further lightly at the center.

## How to remove and install the air inlet panel

### Removing

When removing the air inlet panel for internal cleaning or others, open the panel by 90 degrees and then pull it forward.

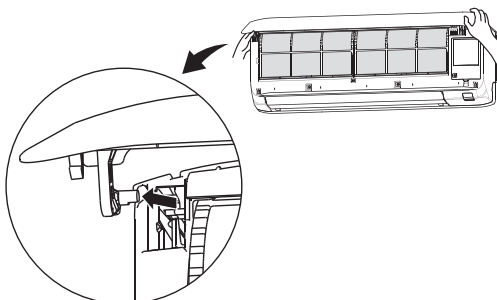

### Installing

Insert the panel arm into the slot on the front panel from the position shown below, hold the panel at both ends of lower part, lower it downward slowly, then push it slightly until the latch works.

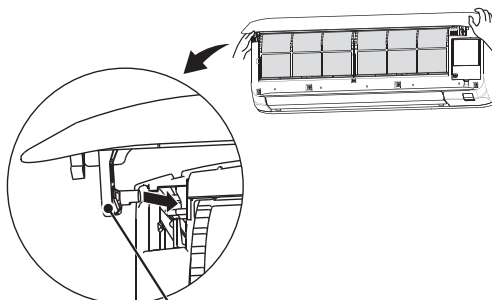

**NOTE**

Cooling/heating is affected by an air filter clogged up with dust etc., and the operation noise becomes louder. It may also use extra electricity. Please clean the air filter at appropriate intervals.

**At the end of the season****1 Perform the fan operation for 2 to 3 hours.**

Dry the inside of the unit.

**2 Stop the unit and turn off the power source.**

The unit consumes approx. 4W even when the unit is not operating. Turning off the power source will help saving energy consumption and cost.

**3 Clean and reinstall the air filters.****4 Clean both the indoor and outdoor units.****5 Remove batteries from the remote control.****At the beginning of the season****1 Ensure that the earth wiring is not snapped nor disconnected.****2 Make sure that there is no corrosion or rust on the base frame of the outdoor unit.****3 Make sure that there are no obstacles blocking the airflow around the air intake and outlet openings of the indoor and outdoor units.****4 Turn on the power source.****5 Insert batteries in the remote control.****Installing, inspecting and replacing the air-cleaning filter**

1. Open the air inlet panel and remove the air filters.  Page 28
2. Remove the filter holders, with the air-cleaning filter installed in the holders, from the air-conditioner.
3. Remove the allergen clear filter (Light orange) from filter holder and inspect the filter. Use a vacuum cleaner to remove any dust or dirt from the allergen clear filter. Replace the allergen clear filter if it cannot be cleaned or if it has been for about 1 year.  
(The allergen clear filter should be replaced after about 1 year of used. However, the actual replacement period may vary depending on the conditions in which the filter is used.)

Remove the photocatalytic washable deodorizing filter (orange) from the filter holder and inspect the filter. Periodically, remove any dust or dirt from the photocatalytic washable deodorizing filter. If the photocatalytic washable deodorizing filter is particularly dirty, it may be washed with water. However, the filter is fragile so be sure to wash it installed in the filter holder to avoid damaging it. After washing the filter, place it in sunlight to dry. Placing the filter in sunlight restores the deodorizing effect.

(Do not dispose of the filter holders. They are reusable.)

4. Install the air-cleaning filter in the filter holders, and then install the filter holders in the air-conditioner.

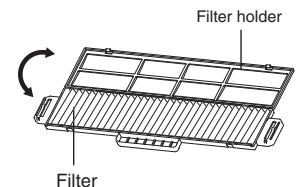
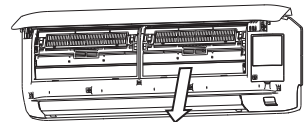
**NOTE**

- The allergen clear filter and the photocatalytic washable deodorizing filter may be installed on either the right or left side of the air-conditioner.
- Install the allergen clear filter with the light orange side on front side.

5. Install the air filters and close the air inlet panel.  Page 28

**CAUTION**

- The heat exchanger may injure your fingers.
- Stand firmly on a stepladder or other stable object when removing the air inlet panel and filters.

For replacing the air-cleaning filter, contact your dealer.

Item	Feature	Color
Allergen clear filter	The power of enzyme is used to eliminate allergy-causing allergens that accumulate on the filter.	Light orange
Photocatalytic washable deodorizing filter	Sources of odors on the filter are broken up, resulting in a deodorizing effect.	Orange

# Proper installation

## Suitable installation position

- Do not put any obstruction in front of the indoor unit, preventing proper ventilation and functioning.
- Do not install the unit in any of the following places:
  - Where there is a danger of leaking flammable gases.
  - Where there is substantial splashing of oil.
- Malfunctioning due to corrosion may occur if the unit is installed in a spa where sulfide gases are generated, or in a seaside resort exposed to sea breezes. Contact your dealer.
- The air-conditioner and remote control must be at least 1 meter away from a TV set or radio.
- Drain the dehumidified liquid from the indoor unit into a spot that drains well.

## Pay attention to operating noises

- When you install the unit, take care to choose a place that can comfortably stand the weight of the unit and does not increase the operating noise or vibration. If vibration is transmitted through the house, fix the unit with the aid of vibration-proof pads between the unit and the fittings.
- Select a place where cold or hot air, operation noises from the indoor and outdoor units do not cause any inconvenience to your neighbours.
- Do not leave any obstacles near the outlet and inlet of the outdoor unit. This may cause malfunctioning and increased operating noise.
- If you hear an irregular noise during operation, contact your dealer.

## Inspection and maintenance

Depending on operating environment, the inside of the air-conditioner may become dirty after a few year operations. This will reduce performance. In addition to normal cleaning, we would recommend inspection and maintenance. (This may lead the air-conditioner to having a longer life without any trouble.)

- Contact your dealer, or any distributor, for inspection and maintenance. (There will be a charge for this service).
- We would recommend inspection and maintenance to be carried out during the off-season.
- If the supply cord of this appliance is damaged, it must only be replaced by a repair shop appointed by the manufacturer, because special purpose tools are required.

# Troubleshooting

Please carry out the following checks before making a service call.

### **The air-conditioner does not work at all.**

- Has the power switch been turned off?
- Has the timer been set in the "ON" position?
- Is there a power failure or a blown fuse?

### **Poor cooling or heating**

- Have you set the thermostat at a suitable temperature?
- Is the air filter clean? (Not clogged?)
- Have you left any doors or windows open?
- Is there any direct sunlight entering the room?
- Is there a heat source in the room?
- Are there too many people in the room?

If the air-conditioner does not operate properly after you have checked the left points, or if any doubt still exists after you have consulted page 31, or if things happen as shown on page 32, switch off the power and contact your dealer.



# Notice

## Airflow

<p><b>Air is not blown out when starting the HEATING operation.</b>            RUN light blinks slowly            (1.5 seconds ON, 0.5 seconds OFF)</p>	<p>Airflow has stopped to prevent blowing out of cold air until the indoor heat exchanger has warmed up. (2 to 5 minutes)</p>
<p><b>Air is not blown out for 5 to 15 minutes or cool air is blown out for a moment at HEATING operation.</b>            RUN light blinks slowly            (1.5 seconds ON, 0.5 seconds OFF)</p>	<p>When outdoor temperature is low and humidity is high, the unit sometimes performs defrosting automatically. Please wait. During defrosting, water or steam may release from the outdoor unit.</p>
<p><b>Air is not blown out when starting the DRY operation.</b>            (RUN light is on)</p>	<p>The indoor fan may stop to prevent re-evaporation of dehumidified moisture and to save energy.</p>

## Noise

<p>You hear a slight gurgling sound.</p>	<p>This is caused by refrigerant moving within the unit.</p>
<p>You hear a slight cracking sound.</p>	<p>This is caused by heat expansion or contraction.</p>
<p>You hear a hissing or clicking sound.</p>	<p>This is caused by the operation of the refrigerant control valves or electric components.</p>
<p>Whistling noise is heard from the outdoor unit.</p>	<p>This means that the rotation speed of the compressor is increasing or decreasing.</p>
<p>Sometimes a "Shooooo" sound might come for a short time from the unit that is turned off.</p>	<p>This is the sound when operation of another indoor unit is stopped.</p>

## Others

<p><b>The unit does not restart immediately after you have stopped it.</b>            (RUN light is on)</p>	<p>Restart is blocked for 3 minutes after you have stopped the operation to protect the unit.</p> <p>The 3 minutes protection timer in the microcomputer automatically starts it up again.</p>
<p><b>Some steam releases during COOL operation.</b></p>	<p>This may occur if the room's temperature and humidity are very high. It disappears as soon as the temperature and humidity decrease.</p>
<p><b>There is a slight smell.</b></p>	<p>Air blown out during operation may smell. This is caused by tobacco or cosmetics adhering to the unit.</p>
<p><b>After a power cut, the unit does not restart even if power has been restored.</b></p>	<p>If the auto restart function is not set, the unit will not restart automatically. Use the remote control to start the operation again.</p>
<p><b>Remote control signals are not received.</b></p>	<p>Remote control signals may not be received if the signal receiver on the air-conditioner is exposed to direct sunlight or other bright light.            If so, block the sunlight or reduce the other light.</p>
<p><b>Moisture may form on the air outlet grills.</b></p>	<p>If the unit is operated for a long time in high humidity, moisture may form on the air outlet grills and start dripping.</p>
<p><b>Fan will not stop immediately after unit operation is stopped.</b></p>	<p>Indoor fan : Fan will not stop after 2 hours if set to SELF CLEAN operation.            Outdoor fan : Fan will not stop about a 1 minute period in order to protect the unit.</p>
<p><b>RUN light stays on even though operation was stopped.</b></p>	<p>The RUN light illuminates during SELF CLEAN operation. Run light will turn off when SELF CLEAN operation ends.</p>

# Contact your dealer

- Turn off the power switch immediately and inform your dealer in any of the following situations:

- The fuse or switch blows continuously.
- The cable becomes extremely hot.  
The covering of the cable is cracked.
- The TV, radio or other equipment starts to malfunction.
- A switch does not activate properly.
- A strange noise is heard during operation.
- When abnormalities occur, turn off the power source immediately and turn it on after 3 minutes. Restart the operation with ON/OFF button of the remote control and the abnormalities still continue.
- The RUN and TIMER lights on the unit display section blink quickly (0.5 seconds ON; 0.5 seconds OFF) or the lights do not work.

## Auto restart function

- Auto restart function records the operational status of the air-conditioner immediately prior to be switched off by a power cut, and then automatically resumes operations after the power has been restored.
- The following settings will be canceled:
  - ① Timer settings
  - ② HIGH POWER operations

### NOTE

- Auto restart function is set at on when the air-conditioner is shipped from the factory. Consult with your dealer if this function needs to be switched off.
- When power failure occurs, the timer setting is canceled. Once power is resumed, set the timer again.

## About the multiple air-conditioners

### Simultaneous Operation

- The air-conditioners cannot be in different operating modes at the same time, such as one unit being in the "Cool" mode and one unit being in the "Heat" mode.
- When conducting different operations, the air-conditioner that was operated first will be given priority, so the air-conditioner that is operated after that will conduct air blowing operation.
- When you want to give priority to the air-conditioner that was started later, either stop the air-conditioner that has priority or change the operation type of the unit operated first to match that of the unit operated second.
- When other indoor units are operating in different modes, the RUN light illuminates.

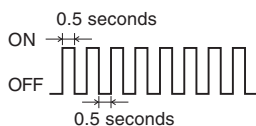

### Automatic Operation

- When the remote control operation switch is in the AUTO mode, the air-conditioner automatically selects either COOL or HEAT mode when operation is started depending on the room temperature.
- During simultaneous operation of air-conditioners, operation modes may be automatically changed in response to the temperatures of the individual rooms; this will result in the operation of the outdoor unit being stopped. In such a case, COOL or HEAT mode should be used instead of AUTO mode. (This is only relevant when more than one air-conditioner unit is being used.)

### Refrigerant (oil) recovery operation

- If all of the indoor units are not operated at the same time for an extended period, the cooling or heating performance may temporarily decrease. This is in order to control the recovery of the refrigerant (oil) in the stopped indoor unit(s). At this time, the sound of refrigerant flowing may be heard from the stopped indoor unit(s).

# Self diagnosis function

■ We are constantly trying to do better service to our customers by installing such judges that show abnormality of each function as follows

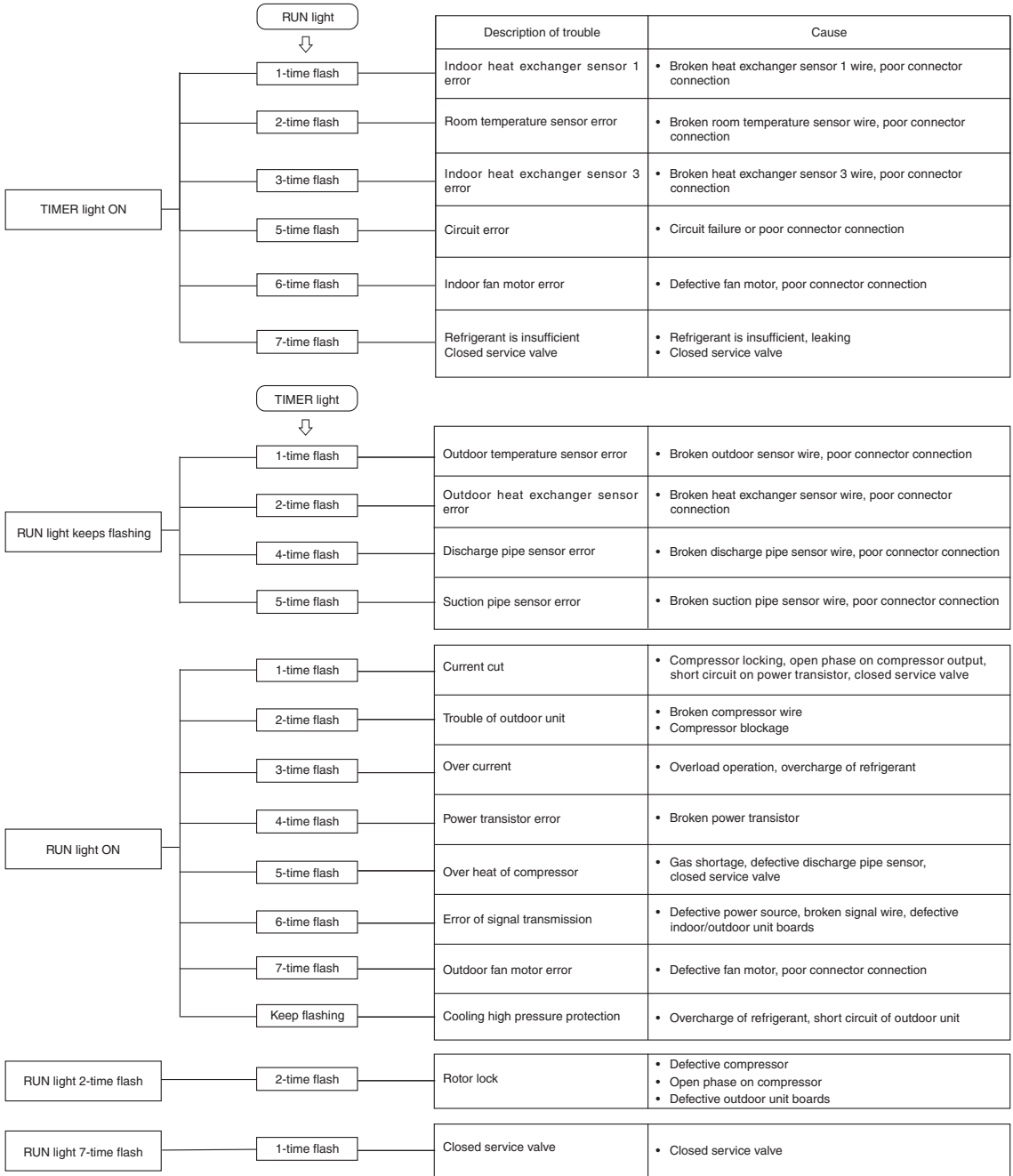

# DRED

- This air-conditioner complies with the DRED (Demand Response Enabling Devices) standard AS/NZS4755.3.1 and supports demand response modes 1, 2 and 3 (DRM1, 2 and 3). Since the air-conditioner limits the electric power or energy by receiving the DRED input signal, the sense of cooling operation or heating operation may deteriorate over time. The outdoor unit of this air-conditioner is equipped with a terminal block for DRED input and supports ELV (Extra-Low Voltage) complying with AS/NZS60335.1. Under DRED mode, RUN light and TIMER light blink alternately as shown. When the Defrost function becomes effective during DRED operation, the TIMER light blinks quickly.

## Display in DRED mode

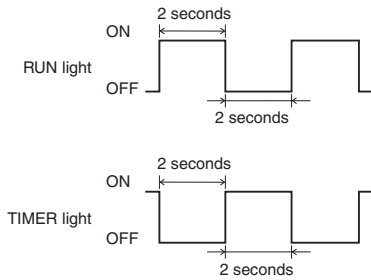

## Display in DRED mode during Defrost operation

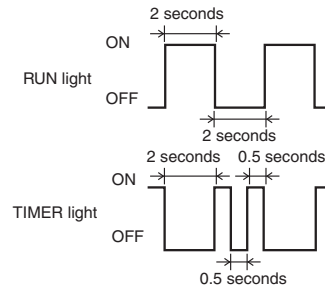









---

**MITSUBISHI HEAVY INDUSTRIES THERMAL SYSTEMS, LTD.**

16-5 Konan 2-chome, Minato-ku, Tokyo, 108-8215, Japan  
<http://www.mhi-mth.co.jp/en/>

**MITSUBISHI HEAVY INDUSTRIES AIR-CONDITIONERS AUSTRALIA, PTY. LTD.**

9C Commercial Road Kingsgrove NSW 2208 PO BOX 318 Kingsgrove NSW 1480  
Tel : +61-2-8571-7977  
Fax: +61-2-8571-7992  
<https://www.mhial.com.au/>